

SPECIFICATION

产品规格书

REFOND P/N 产品型号

RF-MTD**2T08-E1

R&D 研发

Mass Product 量产供货

Contents 目录

1. LED Module Description/ 模组描述.....	3
2.LED Module Specification / 模组规格	4
2.1 Optical-electrical Characteristics(Absolute Maximum Ratings At Ts=25℃)/ 模组光电特性. 4	
2.2 LED Module Schematic And Interface Definition/ 模组电性规格.....	6
2.3 LED Module rule of naming 模组命名规则:	6
3. Product Specification / 产品规格	7
3.1 Outline Dimension / 外形图.....	7
4. LED Module Reliability Test /模组可靠性实验.....	8
5. LED Module Materials Performance Test And Method At Ta=25℃/模组物料性能检测和方法.....	9
6.Packing Criterion/包装标准.....	10
6.1 Package Diagram /包装示意图.....	10
6.2 Blister box Dimensions/吸塑盒尺寸	10
6.3 Carton Dimensions/纸箱尺寸.....	10
6.4 Carton silk printing/纸箱丝印.....	11
6.5 Label Form Specification/标签规格	11
7. Handling Precautions 产品使用注意事项	12

1. LED Module Description/ 模組描述

LED Module designed according to the market mainstream of lamps and lanterns, easy to match, assembly is convenient;

★ 模組根據市場主流燈具設計，容易匹配，組裝方便；

LED Module with high reliability and high safety;

★ 模組可靠性，安全性高；

LED Module use 2835 LED Package, high lighting efficiency, low heat, without Mercury, belong to the environmental protection cold light source;

★ 模組光源採用2835LED光源，光效高，熱量低，不含汞，屬於環保冷光源；

LED Module electrical parameter design in line with the market mainstream LED power supply, easy to match, the assembly is convenient

★ 模組電性參數設計符合市場主流LED電源，容易匹配，組裝方便；

LED Module with lower thermal resistance and good heat dissipation;

★ 模組熱阻低，散熱好；

High CRI , Color temperature more selective.

★ 顯色指數高、色溫選擇性多。

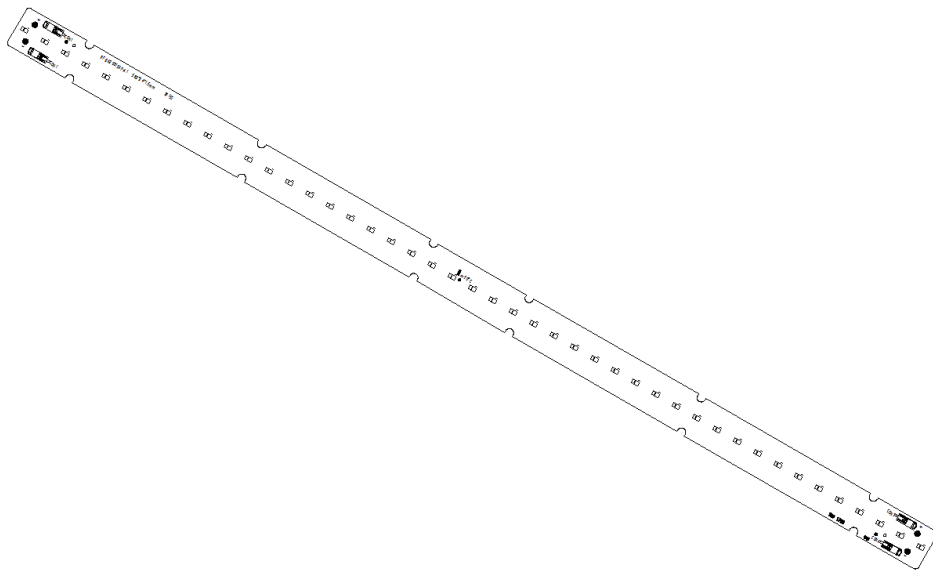

2.LED Module Specification / 模组规格

2.1 Optical-electrical Characteristics(Absolute Maximum Ratings At Ts=25°C)/ 模组光电特性

Tab.2-1 Optical-electrical Characteristics 模组光电特性

Refond PN 瑞丰产品料号	模组参数 Module Characteristics						
	电流Current (mA)	电压 Voltage(V)		功率 Power(W)		模组光通量 Module LM	
	Typ	Min	Max	Min	Max	Min	Max
RF-MTD302T08-E1 (2870-3220K)	180	39	46.5	6.868	7.37	1100	1284
RF-MTD352T08-E1 (3220-3700K)	180	39	46.5	6.868	7.37	1156	1352
RF-MTD402T08-E1 (3700-4275K)	180	39	46.5	6.868	7.37	1217	1423
RF-MTD502T08-E1 (4740-5250K)	180	39	46.5	6.868	7.37	1217	1423
RF-MTD652T08-E1 (5910-7175K)	180	39	46.5	6.868	7.37	1217	1423
试条件(I mA)Test condition	Color Rendering Index (显指)			Min	Max	Typ	
180	83			80	84	83	
SDCM 模组色容差为					≤4.2		

Tab.2-2 Absolute Maximum Ratings at Ts=25°C 模组相关参数绝对最大值

Parameter (参数)	Symbol (符号)	Rating (值)	Units (单位)
Forward Current (正向电流)	I _F	180	mA
Peak Forward Current (峰值电流)	I _{FP}	450	mA
Reverse Voltage (反向电压)	V _R	5	V
Electrostatic Discharge (HBM) (静电)	E _{SD}	2000	V
Operating Temperature (操作温度)	T _{OPR}	-40 ~ +85	°C
Storage Temperature (储存温度)	T _{STG}	-40 ~ +100	°C
Junction temperature (单颗 LED 结温)	T _J	115	°C

2.2 LED Module Schematic And Interface Definition/ 模組電性規格

Fig.2-2ED Module connection 模組電性圖

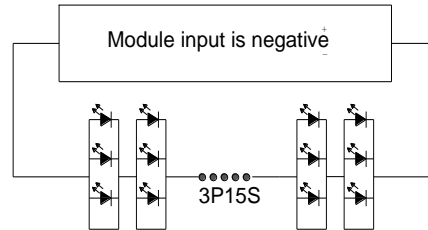

2.3 LED Module rule of naming 模組命名規則:

RF - MT D 40 2 T 08 - E 1

- 瑞豐版本號 (1 : 第一版本)
Refond version number (1: the first version)
- 模組方式 (E : 直下式)
module emitting light way (E: Top view)
- 模組功率 (08 : 模組功率 8W)
LED module power: (08: LED module is 8W)
- 模組顯色指數 (H: 85≥T > 80)
LED module CRI (H: 85≥T > 80)
- LED 型號 (2 : 2835)
LED Package type (2: 2835)
- 模組色溫 (40 : 3700-4275K)
LED Module CCT (40: 3700-4275K)
- 模組類型 (D : 直下式面板燈模組)
LED module type (D: DLED Panel light module)
- 模組部代碼
Module department code
- 公司簡稱代碼 (RF:瑞豐)
Refond company abbreviation(RF: Refond)

3. Product Specification / 产品规格

3.1 Outline Dimension / 外形图

3.1.1 Refond Drawings / 瑞丰模组外形图

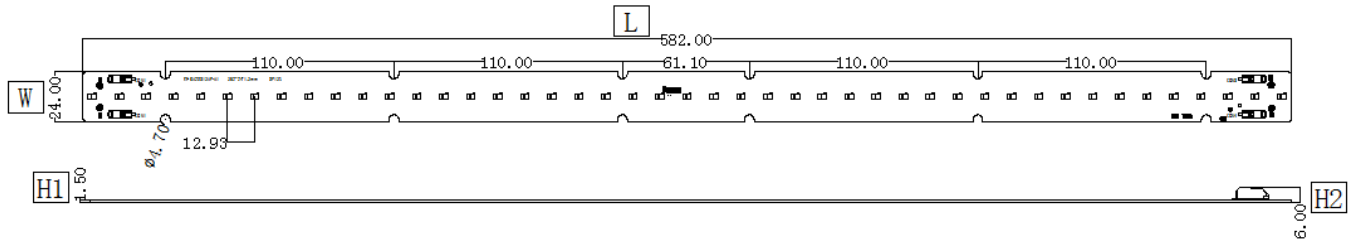

	Dimension 尺寸	Specification 规格	Tolerance 公差
L	Module Length 模组长度	582	±0.3
W	Module Width 模组宽度	24	±0.3
H1	PCB Thickness PCB 厚度	1.5	±0.16
H2	Height of Module 模组高度	6	±0.3

4. LED Module Reliability Test /模组可靠性实验

Tab 4-1 Light Bar Reliability Test 灯条可靠性实验

Test Item/ 测试项目	Test Conditions/ 测试条件	Test Time/ 测试时长	Number Of Test/ 测试数量	Judgement Criteria/判 定标准
Operating Life At Room Temperature/ 常温测试	$T_A=25^{\circ}\text{C}$ $I_F=180\text{mA}$ $T_J<115^{\circ}\text{C}$	500Hrs	0/6	1. $\Delta\Phi<30\%$, $V_f<110\%$, $\text{CIE}\Delta x/\Delta y<0.015$ 2.No catastrophic failure
Operating Life At High Temperature/ 高温测试	$T_A=60^{\circ}\text{C}$ $I_F=180\text{mA}$ $T_J<115^{\circ}\text{C}$	500Hrs	0/6	
Operating Life At High Temperature And Humidity/ 高温高湿测试	60°C $R_H=90\%$ $I_F=180\text{mA}$ $T_J<115^{\circ}\text{C}$	500Hrs	0/6	
Thermal Shock/ 冷热冲击	-40°C 15min $\uparrow\downarrow 10\text{S}$ 85°C 15min	100 cycle	0/6	No Dead LED

Notes 备注：

voltage distribution, heat dissipation and others. 以上可靠性测试是基于瑞丰现有实验平台单颗/条 LED 在良好散热条件验证下的结果。客户端将 LED 应用于串、并联线路时，需自行评估电流、电压分配、散热等问题。

5. LED Module Materials Performance Test And Method At Ta=25°C/模组 物料性能检测和方法

Tab 5-1 Light Bar Materials Performance Test And Method Ta=25°C灯条物料性能检测和方法

Test Item/项目	Test Conditions/指标	Test Methods/测试方法
LED Optical-electrical Characteristics/LED 光电参数	Compliance With Specifications/ 符合规格书	Integrating Sphere/ 积分球测试
Connector Pull Force/ 连接器推拉力	$\geq 7\text{kgf}$	Notes/ 见备注
LED Push & Pull Force/ LED 推拉力	$\geq 3\text{kgf}$	
LED Welding Standards/ LED 焊接品质	Offset Specifications/偏移规格: X Shift /X 轴 $\leq \pm 0.15\text{mm}$; Y Shift/ Y 轴 $\leq \pm 0.15\text{mm}$; Angle/角度 $\leq \pm 3^\circ$;	

Notes 备注 :

Fig 5-1 Push & Pull Test Equipment 推拉力测试设备

Fig 7-2 Push & Pull Test Method 推拉力测试方法

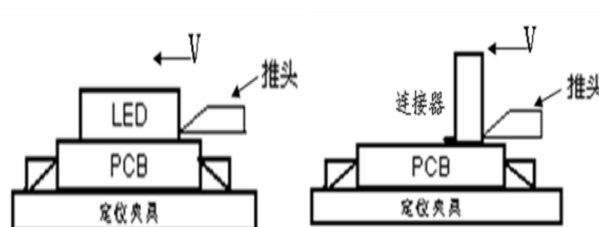

6. Packing Criterion/包装标准

6.1 Package Diagram /包装示意图

Fig 8-1 Package Diagram /包装示意图

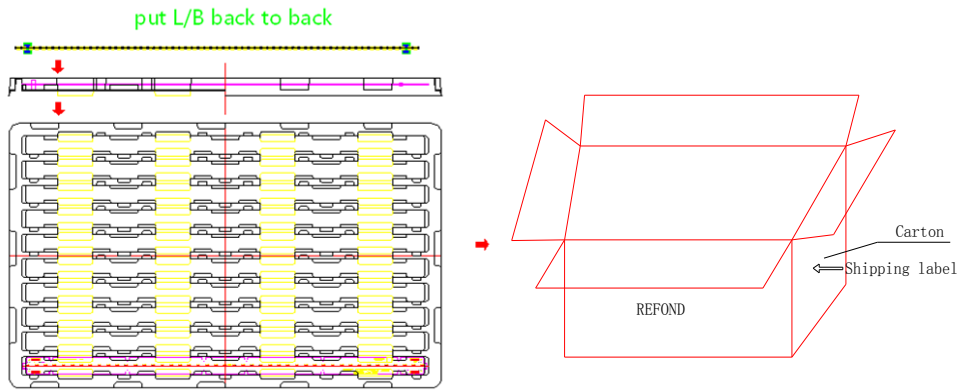

6.2 Blister box Dimensions/吸塑盒尺寸

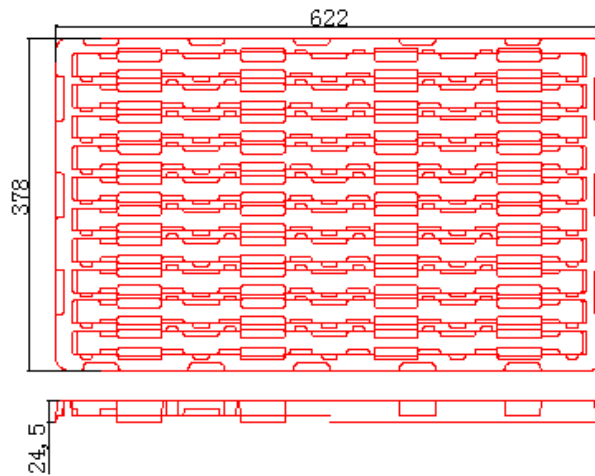

6.3 Carton Dimensions/纸箱尺寸

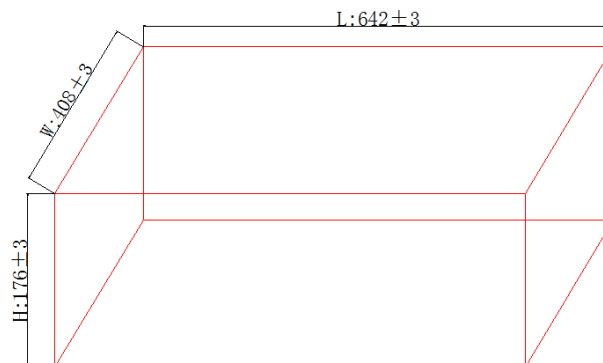

6.4 Carton silk printing/纸箱丝印

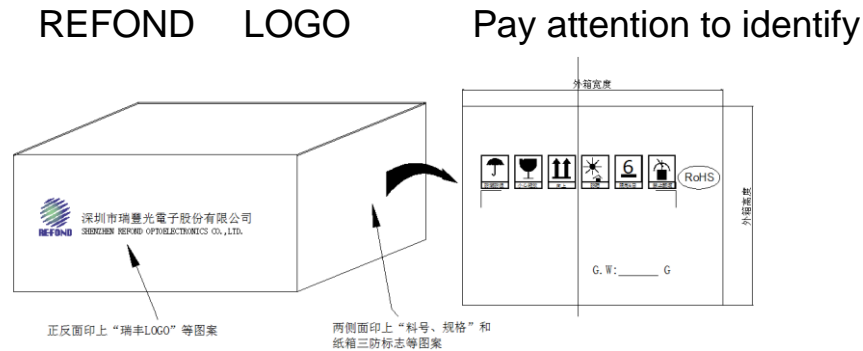

6.5 Label Form Specification/标签规格



出货标签			
客户料号 /customer PN			
瑞丰料号/P.N			
色区/BIN CODE		亮度档/LM	
电压档/VF		色温/CCT	
显指/CRI		数量/QTY	
净重/N.W		日期/DATE	

Package quantity(160PCS/carton)整箱包装数量(160PCS/箱) :

1. A box of 9 plastic boxes, including 8 plastic ones, has an empty one which is used as a cover to protect the modules underneath.

一箱共装 9 个吸塑盒，其中有 8 个吸塑盒装，有一个吸塑盒是空的，用来当做盖来保护下面装的模组。

2. Plastic boxes should be put layer by layer with a positive and negative layer stacked together, a total of 8 layers, and a layer of empty plastic box as protection one is supposed to be put on the top.

纸箱吸塑盒按一正一反一层一层叠加放置,共放 8 层,最上面一层再放一层空吸塑盒保护模组。

3. Each plastic box has a total of 20PCS module installed and contains 10 slots, in which 2PCS module should be put back to back.

每个吸塑盒上共装 20PCS 模组，一个吸塑盒有 10 个卡曹，吸塑盒每个卡曹内背靠背放 2PCS 模组。

The cartons of the whole box can be subjected to six layers. As for the height of the stack, please make decision based on the actual situation.

整箱模组纸箱可以承受的叠放数量是6层,具体纸箱叠放高度，请以实际情况决定。

7. Handling Precautions 产品使用注意事项

(1) LED operating environment and sulfur element composition cannot be over 100PPM in the LED mating usage material. This is provided for informational purposes only and is not a warranty or endorsement. LED 工作环境及与 LED 适配的材料中硫元素及化合物成份不可超过 100PPM. 这只是一个建议，不作任何品质担保。

(2) In order to prevent external material from getting into the inside of LED, which may cause the malfunction of LED, the single content of Bromine element is required to be less than 900PPM, the single content of Chlorine element is required to be less than 900PPM, the total content of Bromine element and Chlorine element in the external materials of the application products is required to be less than 1500PPM. This is provided for informational purposes only and is not a warranty or endorsement. 为了防止外界物质进入 LED 内部以造成 LED 的损伤，所处环境及所用套件等等，单一的溴元素含量要求小于 900PPM，单一氯元素含量要求小于 900PPM，溴元素与氯元素总含量必须小于 1500PPM. 这只是一个建议，不作任何品质担保。

(3) VOCs (Volatile organic compounds) emitted from materials used in the construction of fixtures can penetrate silicone encapsulants of LEDs and discolor when exposed to heat and photonic energy. The result can be a significant loss of light output from the fixture. Knowledge of the properties of the materials selected to be used in the construction of fixtures can help prevent these issues. Refond advises against the use of any chemicals or materials that have been found or are suspected to have an adverse affect on device performance or reliability. To verify compatibility, Refond recommends that all chemicals and materials be tested in the specific application and environment for which they are intended to be used. Attaching LEDs, do not use adhesives that outgas organic vapor. 应用套件中的挥发性物质会渗透到 LED 内部，在通电产生光子及热的条件下，会导致 LED 变色，进而造成严重光衰，提前了解套件材料能够避免产生这些问题。瑞丰反对使用任何对 LED 器件的性能或者可靠性有害的物质或材料，不管这些材料是已经证实了的还是仅仅怀疑有害。针对特定的用途和使用环境，瑞丰建议对所有的物质和材料进行相容性的测试。在贴装 LED 时候，不要使用能产生有机挥发性气体的粘结剂。

(4) Handle the component along the side surface by using forceps or appropriate tools; do not directly touch or Handle the silicone lens surface, it may damage the internal circuitry. 通过使用适当的工具从材料侧面夹取，不可直接用手或尖锐金属压胶体表面，它可能会损坏内部电路。

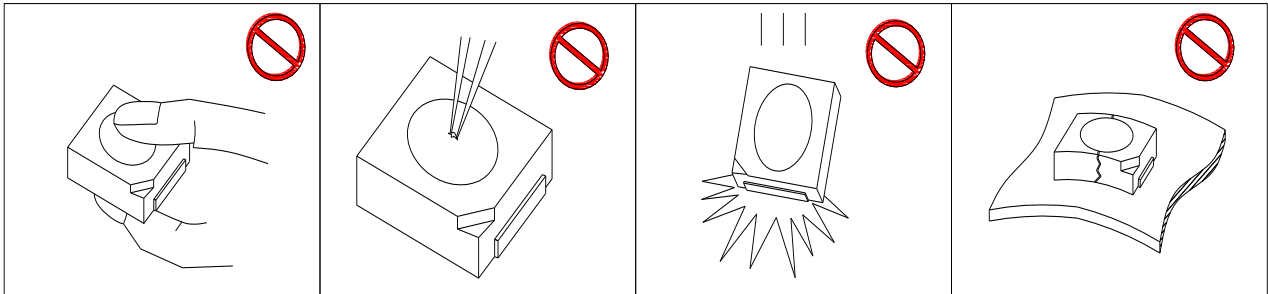

(5) In designing a circuit, the current through each LED can not be exceed the absolute maximum rating specified for each LED. In the mean while, resistors for protection should be applied, otherwise slight voltage shift will cause big current change, burn out may happen. The driving circuit must be designed to allow forward voltage only when it is ON or OFF. If the reverse voltage is applied to LED, migration can be generated resulting in LED damage. 设计电路时，通过 LED 的电流不能超过规定的最大值，同时，还需使用保护电阻，否则，微小的电压变化将会引起较大电流变化，可能导致产品损毁。电路设计必须保证只有在开启或者关闭的时候出现正向电压的变化，不要施加反压，否则会损坏 LED。

(6) Thermal Design is paramount importance because heat generation may result in the Characteristics decline, such as brightness decreased, Color change and so on. Please consider the heat generation of the LEDs when making the system design. LED 容易因为自身的发热和环境的温度改变而改变，温度升高会降低 LED 发光效率，影响发光颜色，所以在设计时应充分考虑散热问题。

(7) Compared to standard encapsulants, silicone is generally softer, and the surface is more likely to attract dust, requiring special care during processing. In cases where a minimal level of dirt and dust particles cannot be guaranteed, a suitable cleaning solution must be applied to the surface after the soldering of components. Refond suggests using isopropyl alcohol for cleaning. In case other solvents are used, it must be assured that these solvents do not dissolve the package or resin. Ultrasonic cleaning is not recommended. Ultrasonic cleaning may cause

damage to the LED. 与其他封装胶相比，硅胶通常较软，表面易吸附脏物，应用时应特别注意，当对产品洁净度要求较高时，回流焊以后需要采用恰当的清洗方式，我们推荐用异丙醇作清洗剂，如需要用到其他清洗剂，必须保证不会破坏封装体，超声清洗可能会对 LED 带来损害，不推荐这种清洗方式。

(8) Similar to most Solid state devices; LEDs are sensitive to Electro-Static Discharge (ESD) and Electrical Over Stress (EOS). 像其他的半导体电子器件一样，LED 对静电过流击穿非常敏感，需要做好防护。

9>.NO warping or twisting the Light Bar more than 10°. Forbidding holding the LED part or connector part when handling. 不得弯曲或者扭曲灯条超过10°，手持灯条时，不得触摸LED或者连接器部分。

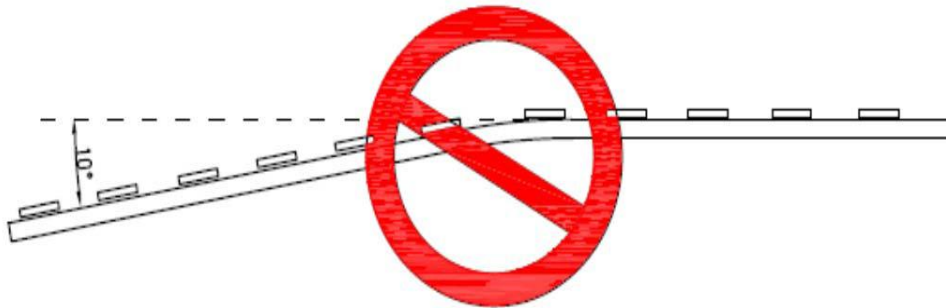

(10) Other points for attention, please refer to our relevant information. 其它注意事项请参照瑞丰相关资料。

Version History/修订历史

Date日期	Revisor修订者	Version版本	Verifier审核	Remarks备注
2021-08-10	范锐文	E/1	邱涛	The first edition



Declare 申明

This specification is written both in English and in Chinese and the latter is formal.

产品规格书以中英文方式书写，若有冲突以中文版本为准。