

LT3004WH-A-Q<3004WH-A-GL

Package Dimension 封装尺寸

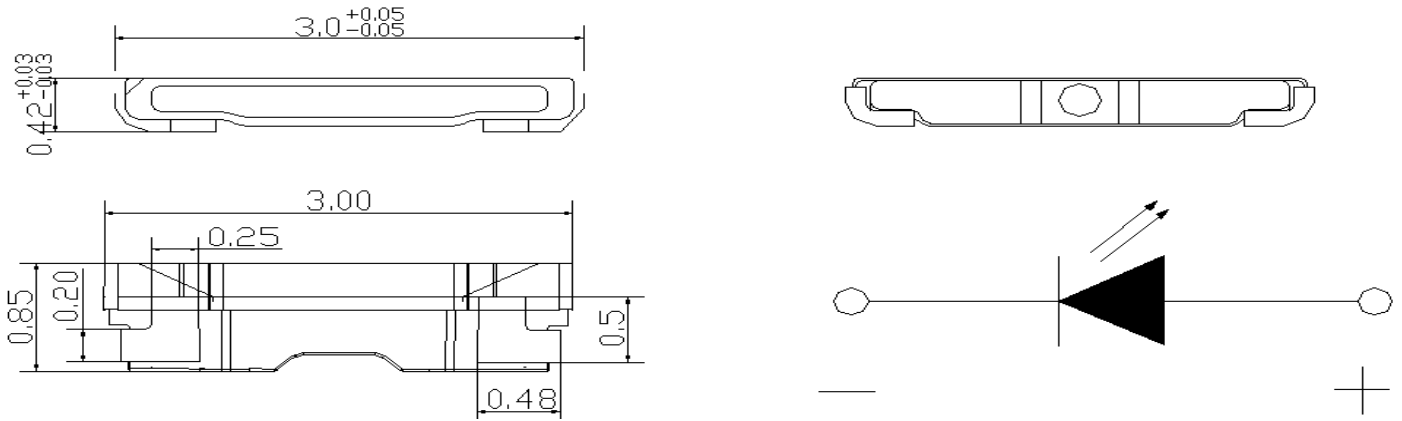

Notes 备注:

1. All dimensions units are millimeters. 所有尺寸标注单位为毫米
2. All dimensions tolerances are ± 0.1 mm unless otherwise noted.除特别标注外, 所有尺寸公差为 ± 0.1 毫米